



GARDTEC

Part Number:

HP25-24R ("T" Plug)

Wire: **SPT1 2 conductor with Red Wire**
105°C, 300 volts

Length: **24" (610mm)**

Listings:



UL listed (E156798)
Rated 10 AMP/125 VAC

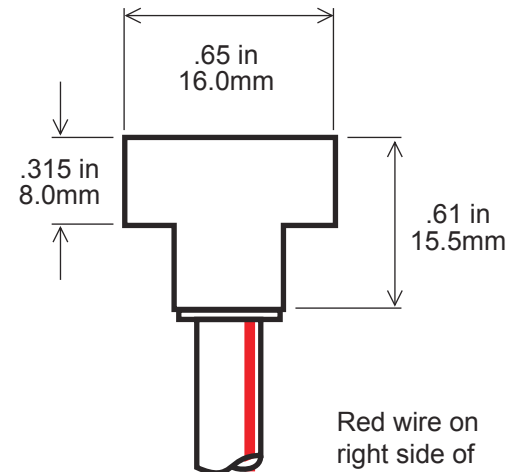
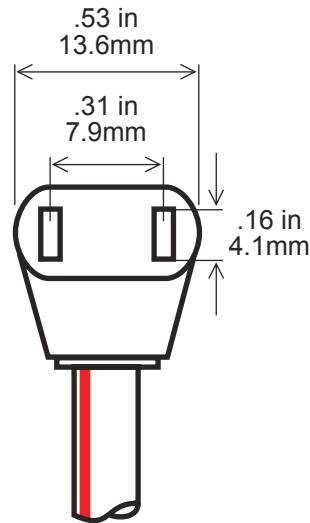

Red wire on
right side of
fan cord.