



**GARDTEC**

Part Number:

**HP25-36R ("T" Plug)**

Wire: **SPT1 2 conductor with Red Wire**  
**105°C, 300 volts**

Length: **36" (914mm)**

Listings:  **UL listed (E156798)**  
**Rated 10 AMP/125 VAC**

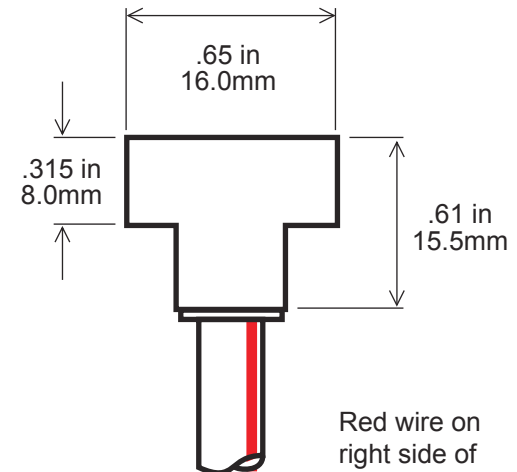
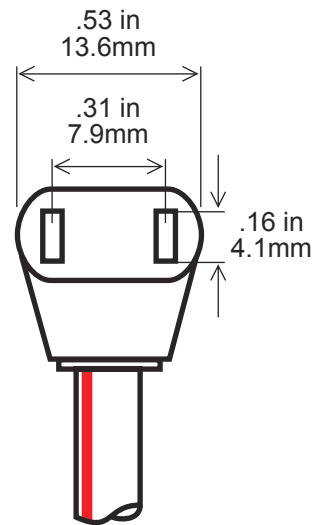

Red wire on  
right side of  
fan cord.