



**GARDTEC**

Part Number:

**SC100-W27**

Material: C1008 Steel

Finish: Bright Nickel Chrome Plating

Ring Diameter: 1.4mm

Rib Diameter: 1.4mm

Disc: T= 1.0mm

General Tolerance Unless Noted:  $\pm 0.5$ mm

Unit: mm

RoHS/REACH Compliant

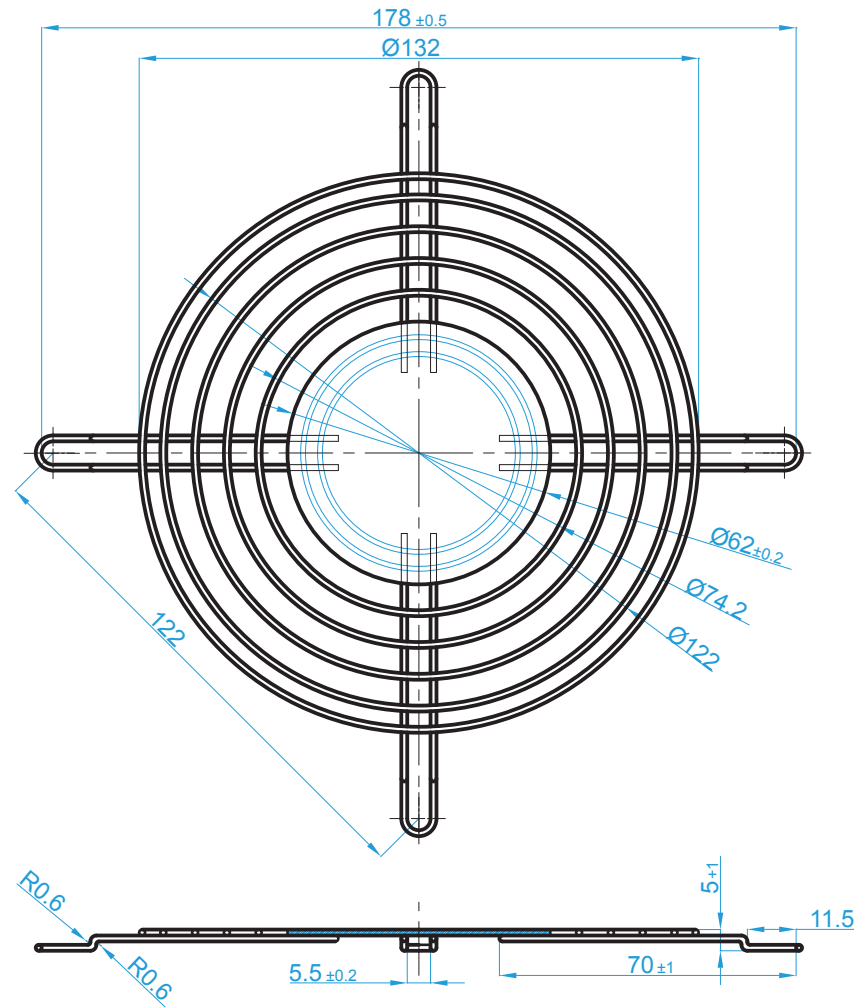

These drawings are the property of Gardtec, Inc and cannot be reproduced for or communicated to a third party without the express written permission of Gardtec, Inc.