

8 7 6 5 4 3 2 1

F

F

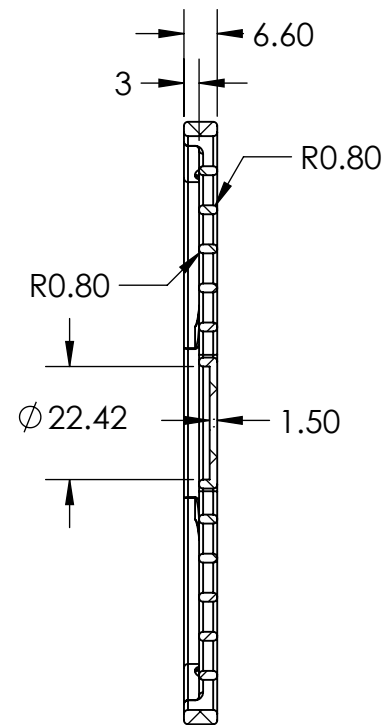
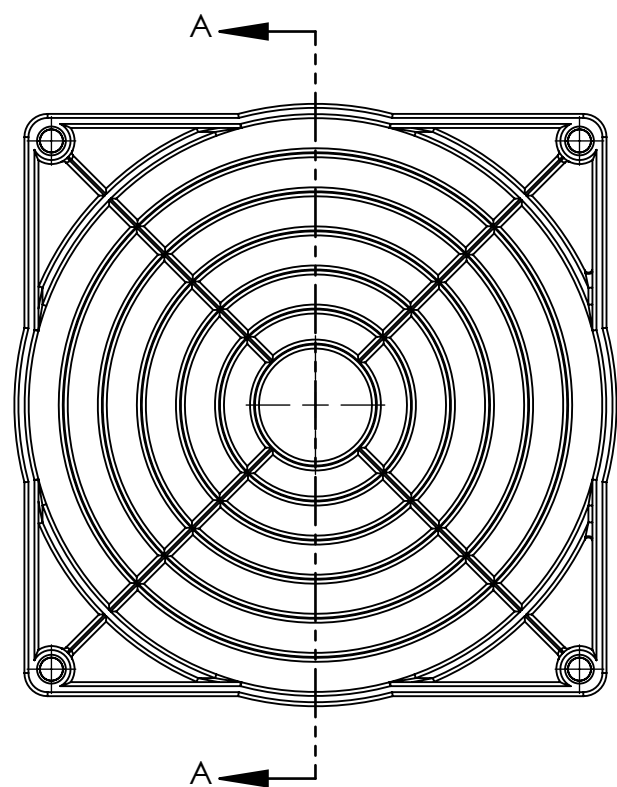
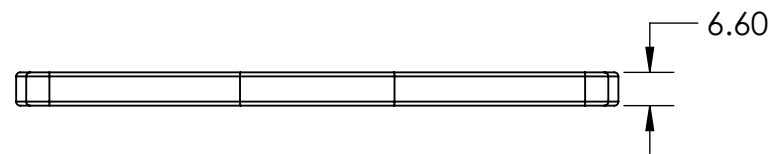
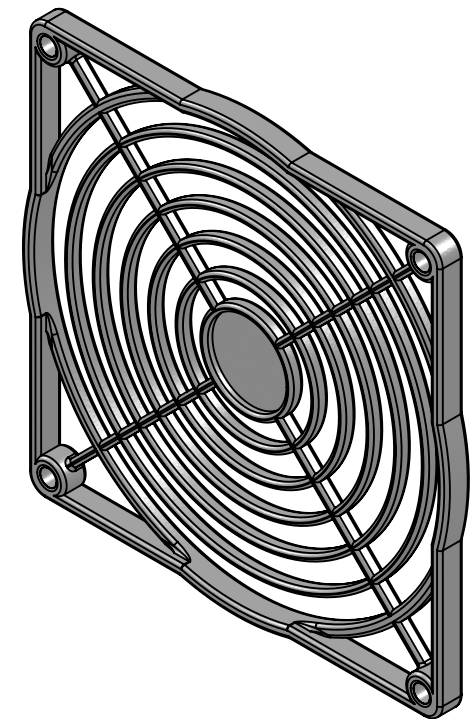
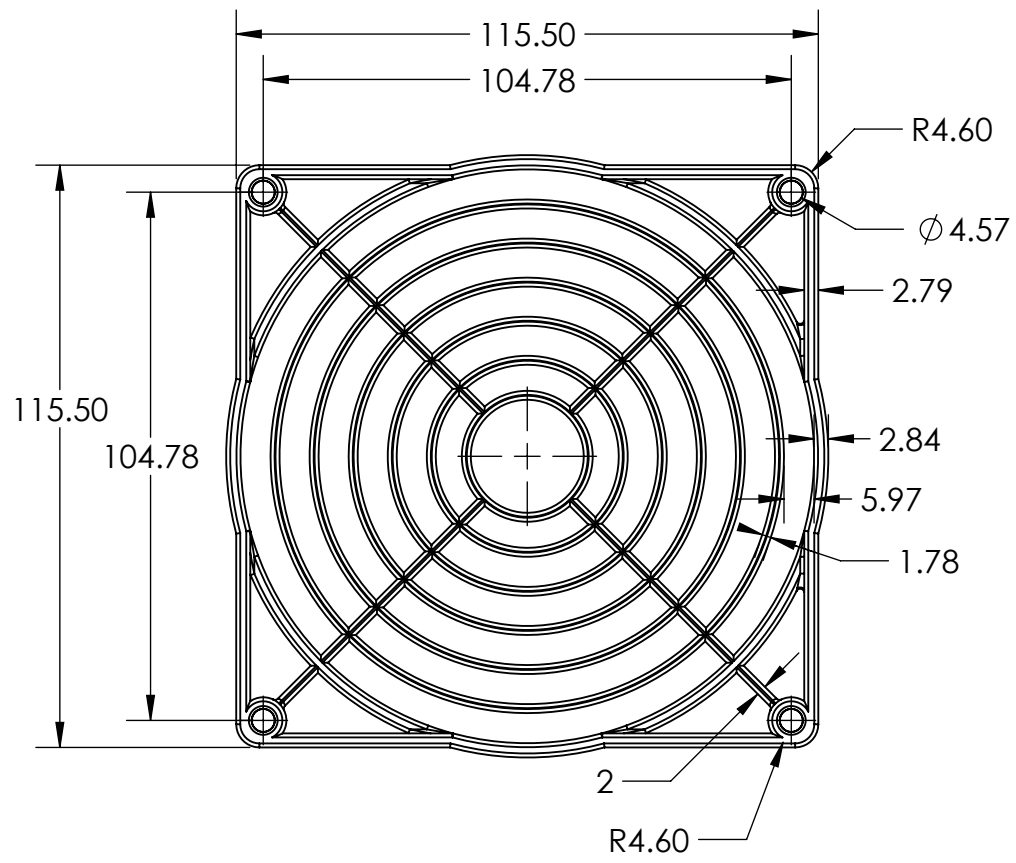

SECTION A-A

C

C

B

B

A

A

8 7 6 5 4 3 2 1

UNLESS OTHERWISE SPECIFIED: DIMENSIONS ARE IN MILLIMETERS SURFACE FINISH: TOLERANCES: LINEAR: ANGULAR:			FINISH:		DEBURR AND BREAK SHARP EDGES		DO NOT SCALE DRAWING		REVISION		
DRAWN			NAME		SIGNATURE		DATE		TITLE: PLASTIC FAN GUARD		
CHK'D									DWG NO. SC120-P71		
APPV'D									A3		
MFG									SCALE:1:1.5		
Q.A							MATERIAL: PBT4130V-0		SHEET 1 OF 1		
							WEIGHT: 0.02				