



GARDTEC

Part Number:

SC120-W16SS

Material: 304 Stainless Steel

Finish: Clear Electro Deposit

Ring Diameter: 1.8mm

Rib Diameter: 2.3mm

General Tolerance Unless Noted: $\pm 0.5\text{mm}$

Unit: mm

RoHS/REACH Compliant

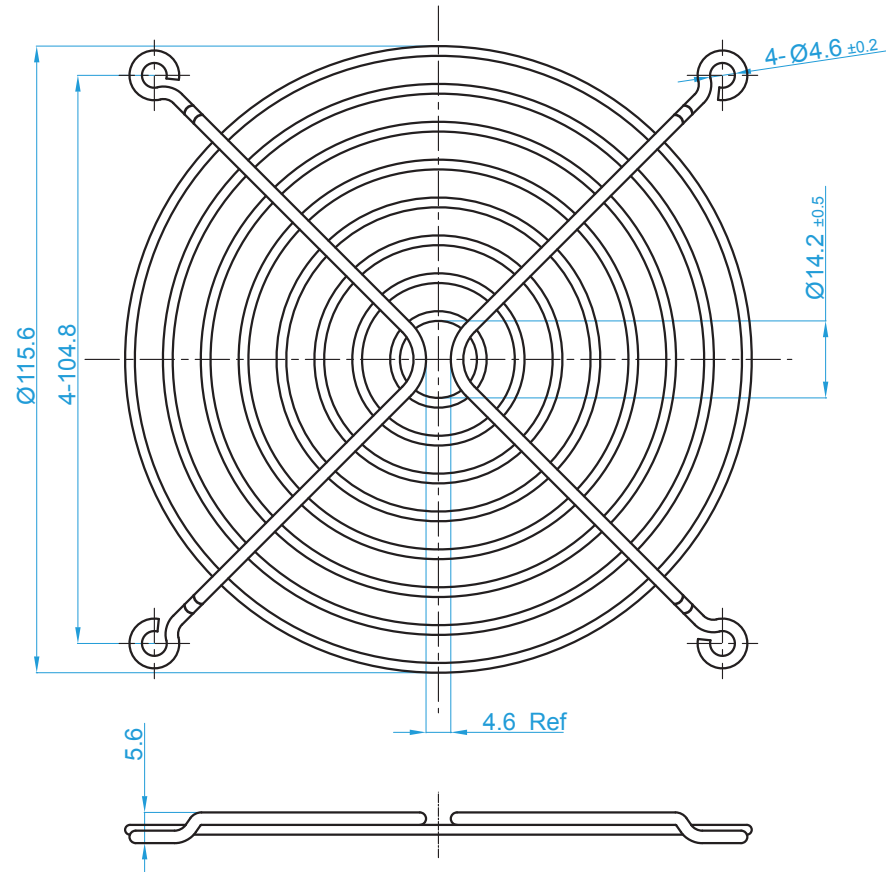

These drawings are the property of Gardtec, Inc and cannot be reproduced for or communicated to a third party without the express written permission of Gardtec, Inc.