



**GARDTEC**

Part Number:

**SC120-W17**

Material: C1008 Steel

Finish: Bright Nickel Chrome Plating

Ring Diameter: 1.8mm

Rib Diameter: 2.0mm

General Tolerance Unless Noted:  $\pm 0.5\text{mm}$

Unit: mm

RoHS/REACH Compliant

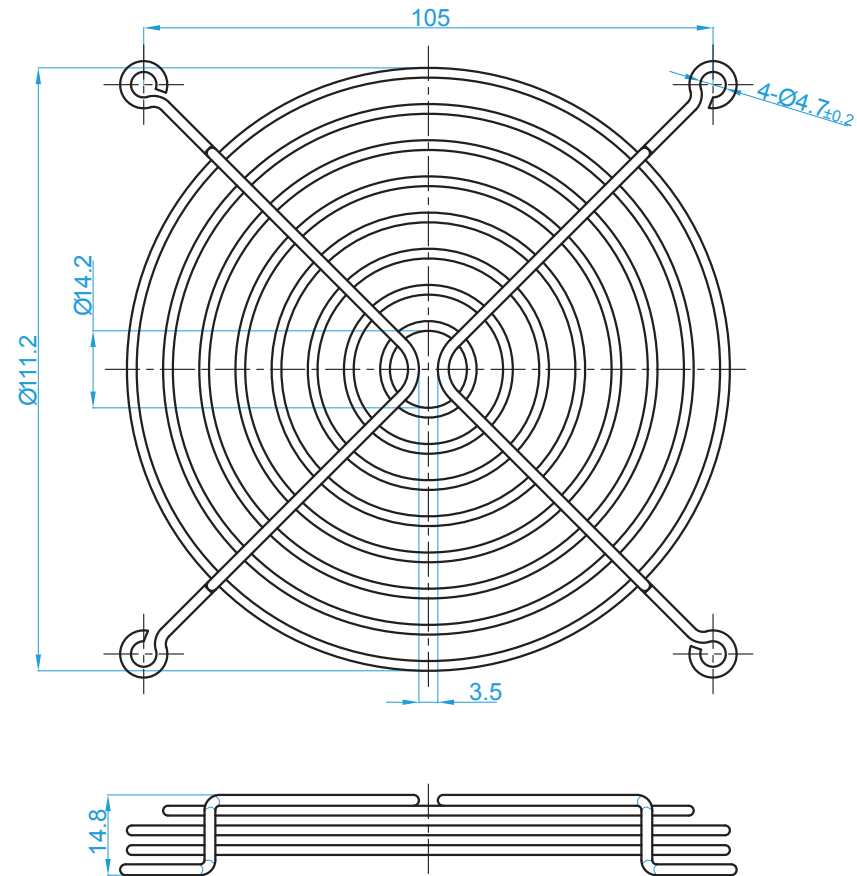

These drawings are the property of Gardtec, Inc and cannot be reproduced for or communicated to a third party without the express written permission of Gardtec, Inc.